

HIGH VOLUME LOW SPEED FANS

APPLICATION

The LHS range of High Volume Low Speed fans are designed to be installed in high ceilings to redistribute air towards floor level, create a cooling effect in summer while they de-stratify the air in winter pushing the warm air down at floor level, for commercial and industrial applications such as warehouses, shopping malls, bar, show room, etc.

CONSTRUCTION

- Upper frame made of painted steel welded structure to protect the motor.
- Decorative canopy to cover the wiring and the ceiling brackets.
- Safety cables and 800mm length downrod provided as standard.
- Specially designed airfoil made from aluminium EN AW 6063 T6. The surface is anodized to avoid corrosion.
- Aerodynamically shaped blade tips made in plastic.
- Hub provided with safety ring.
- Aesthetic hub cover made in plastic.
- High efficiency three-phase EC brushless motor, which are specifically designed for HVLS application, 200-480Vac/3ph/50/60Hz, IP65, with integrated electronic system and EMC filters. Suitable for S1 continuous service. Speed controllable.

FEATURES & BENEFITS

- Top silent operation thanks to the gearless motor and the special airfoil design.
- Ideal to integrate the HVAC system, for energy saving and CO2 emission reduction.
- In winter months they are suitable to de-stratify the air pushing the warm air towards the floor level, so to even the temperature and to prevent the HVAC system to run as hard.
- In summer time the constant and gentle breeze eliminates hot and cool spots in the building by improving the internal environment and creating a natural cooling effect. The air movement also helps keeping the insects away.
- No ordinary maintenance.
- Robust steel structure for long life.
- Key safety features (main security wire, additional stabilising cables, hub safety ring).
- Blade tips to optimise performances and acoustic comfort.
- Hub cover to protect the motor from dust and for a better aesthetics.
- Simplified electrical connection: pre-cabled.
- Integrated EMC filters to prevent electromagnetic interference from other devices.

- Fan are suitable for operating temperatures from 0°C to +50°C.
- Unit performances are tested to the latest AMCA standard meaning accurate information that can be relied upon.
- Designed and manufactured in accordance with Machinery Directive (MD), Low Voltage Directive (LVD), Electromagnetic Compatibility Directive (EMC).

ACCESSORIES

- Different length downrod
- Remote controllers
- I-Beam fixing kit
- Glulam fixing kit

Performance @ 400Vac 50Hz

Description	Fan Diameter	Max Rotation Speed	Max Thrust	Electrical power	Max Air Flow AMCA 230-15			Max Air Flow AMCA 230-99		
					cfm	m ³ /h	SPI ⁽¹⁾ W/(m ³ /s)	cfm	m ³ /h	SPI ⁽¹⁾ W/(m ³ /s)
LHS240	2400	200	89	700	38812	65942	38,2	54889	93256	27,0
LHS300	3000	130	85	450	47412	80554	20,1	67051	113921	14,2
LHS360	3600	110	82	380	55882	94944	14,4	79029	134271	10,2

(1) Max absorbed power / max airflow

(2) min. average air speed 0,8 m/s with testing layout in conformity with AMCA 230

Dimensions

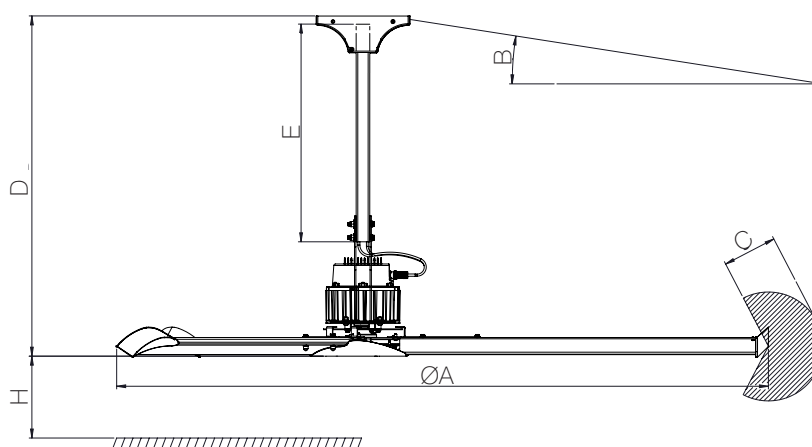

Description	ØA	B max ceiling slope	C min safety distance from side obstruction	D fan height with standard downrod	E standard downrod length	H min fan installation height	Weight
	mm	°	mm	mm	mm	mm	kg
LHS240	2400	20	350	1250	800	2700	62
LHS300	3000		350				64
LHS360	3600		350				67

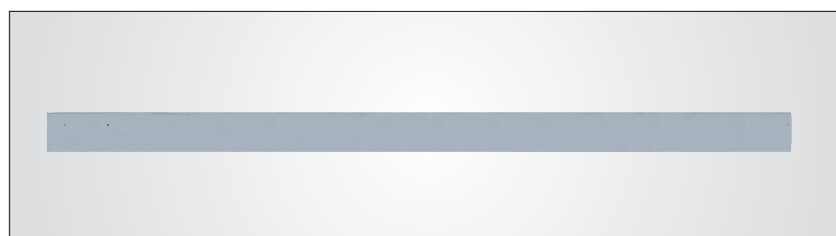

Straight blade profile





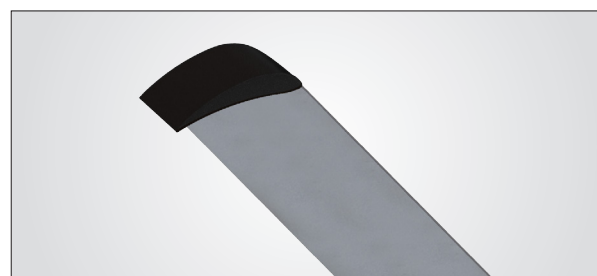



Aesthetic hub cover



45° aerodynamic blade tip

Accessories

Description	 Control panel	 Potentiometer	 Control panel	 Anemometer	 Temperature probe					
	Description	Code	Description	Code	Description	Code	Description	Code	Description	Code
LHS240	CTRL-HS	004154	CTRL-A	002049	CTRL-XWS	005324	AN-SY	002741	SV-10K	005327
LHS300										
LHS360										
Description	 Control panel	Humidity probe	 Downrod	I-Beam	Glulam					
	Description	Code	Description	Code	Description	Code	Description	Code	Description	Code
LHS240	CTRL-XTHI	005325	YGRO-100	005326	TUB300	002220	KT-I-BEAM	003357	KT-GLULAM	004009
LHS300					TUB1500	000817				
LHS360					TUB3000	003757				

CTRL-HS



- 3,5" TFT full touch-screen colour graphic display control panel
- Provides a single point of control for up to 4 units
- To control:
 - ✓ Speed
 - ✓ Fan direction
 - ✓ Alarm warning
- RS-485 ModBus connection
- 24 VaC 50/60Hz (max 4 VA) or 12 ÷ 30VDC (max 2W)
- IP30

CTRL-A



- Potentiometer with front knob to adjust the motor speed
- Provided with two-pole switch (ON/OFF)
- Front yellow led to indicate that the load is active
- Controls one fan only
- 230V~ 50/60Hz
- Supplied with IP55 wall surface box

CTRL-XWS



- To control the ventilation units according to temperature and wind speed
- Dimensions: 160x110x81 mm
- Three operating modes:
 - Mode A: control of ventilation according to wind speed by means of an anemometer (accessory on request) and blocking of the fan according to temperature
 - Mode B: control of ventilation according to room temperature using 1 temperature probe (supplied as standard) and blocking of the fan according to wind speed
 - Mode C: control of ventilation according to room temperature by means of 2 temperature probes (additional temperature probe on request) to manage winter destratification and summer comfort ventilation
- Regulation 0-10V
- 230Vac - 50/60Hz
- Can control up to 10 units
- IP65 wall-mounted casing
- 1 temperature probe included
- Wind speed probe (anemometer) available on request
- Additional temperature probe for Mode C available on request



AN-SY

SV-10K

CTRL-XTHI



- To control the ventilation units according to temperature and THI level
- Dimensions: 160x110x81 mm
- Shower control and auxiliary ventilation activation
- Regulation 0-10V
- 230Vac - 50/60Hz
- Can control up to 10 units
- IP65 wall-mounted casing
- Temperature probe included
- Humidity probe available on request

Downrod

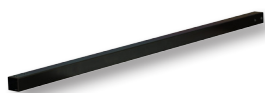

- Downrod made from painted steel
- Different length downrod on request

Description	Weight (kg)	Dimensions (mm)
TUB300	1,3	50x50x3 - L=300
TUB1500	6,6	50x50x3 - L=1500
TUB3000	13,2	50x50x4 - L=3000

I-Beam

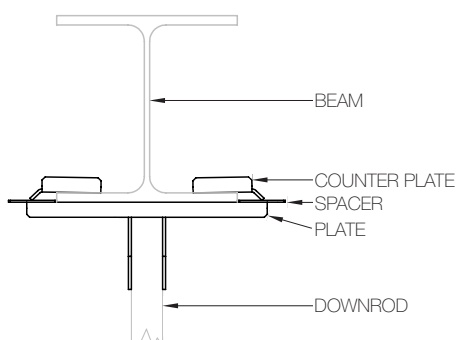

- I-Beam fixing kit suitable for standard IPE, HEA and HEB profiles
- Fixing screws supplied

Model	Range
IPE	from IPE180 to IPE600
HEA	from HEA100 to HEA400
HEB	from HEB100 to HEB300

Glulam

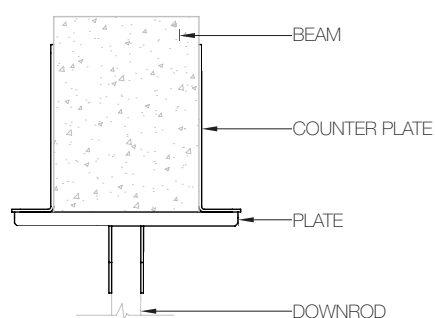

- Fixing kit suitable for rectangular beams with base between 100mm and 260mm
- Fixing screws supplied